

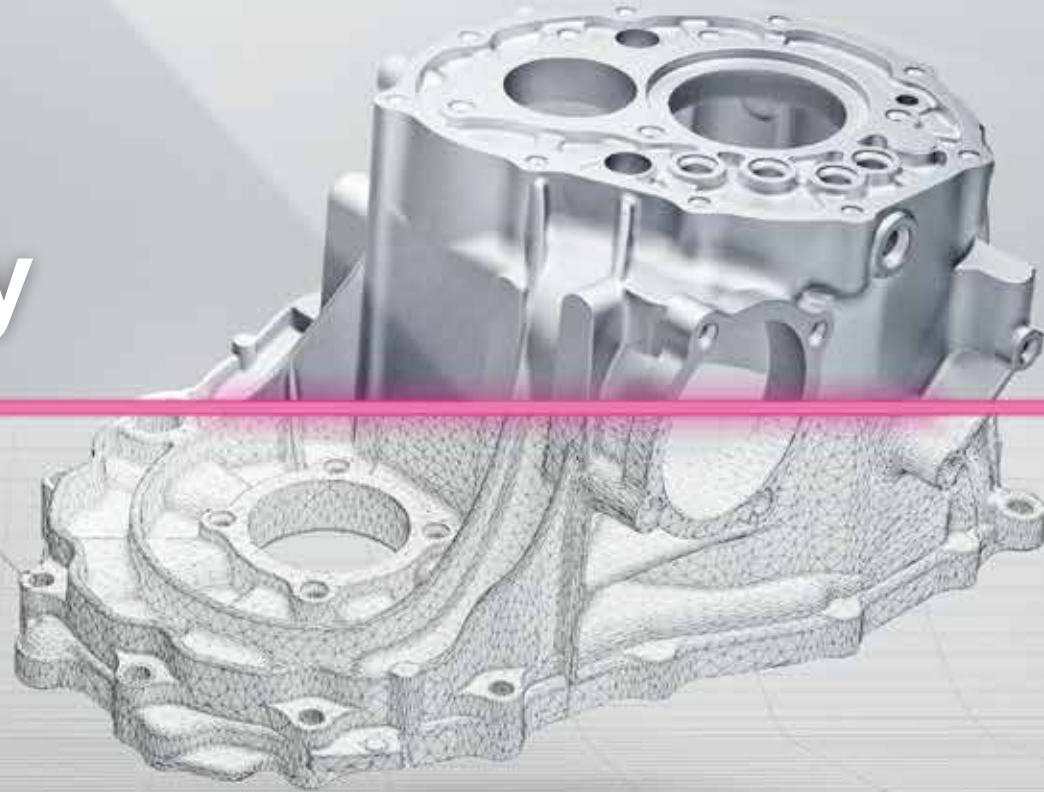

3D-Metrology



Zylinder 1				
	Soll	Ist	Abw.	Prüfung
S	+8.50	1.10(LP)	+9.53	+1.03
		-1.10(LP)	+8.65	+0.15
⊕	Zylinder 1 Ø		0.82	

Engineering Services

AT YOUR SERVICE WITH KNOW-WOW.

In Austria, Switzerland and Liechtenstein.

Tomorrow's solutions won't fall from the sky? Nor do the necessary experts. What is needed is the interplay of years of expertise and the foresight of well-versed specialists in their field.

And that is exactly what we stand for. For more than 23 years. This makes WESTCAM your ideal partner for industrial 3D measurement technology and reverse engineering.

NEWS:

- **WESTCAM AG:** From January 2023 we are the official GOM/ZEISS partner for Switzerland and Liechtenstein too. Supporting your projects from Baden-Dättwil near Zurich.
- **ITM GmbH:** The Styrian metrology professional is now part of the WESTCAM Group. Fresh expertise: Tactile measurement & laser tracker measurement

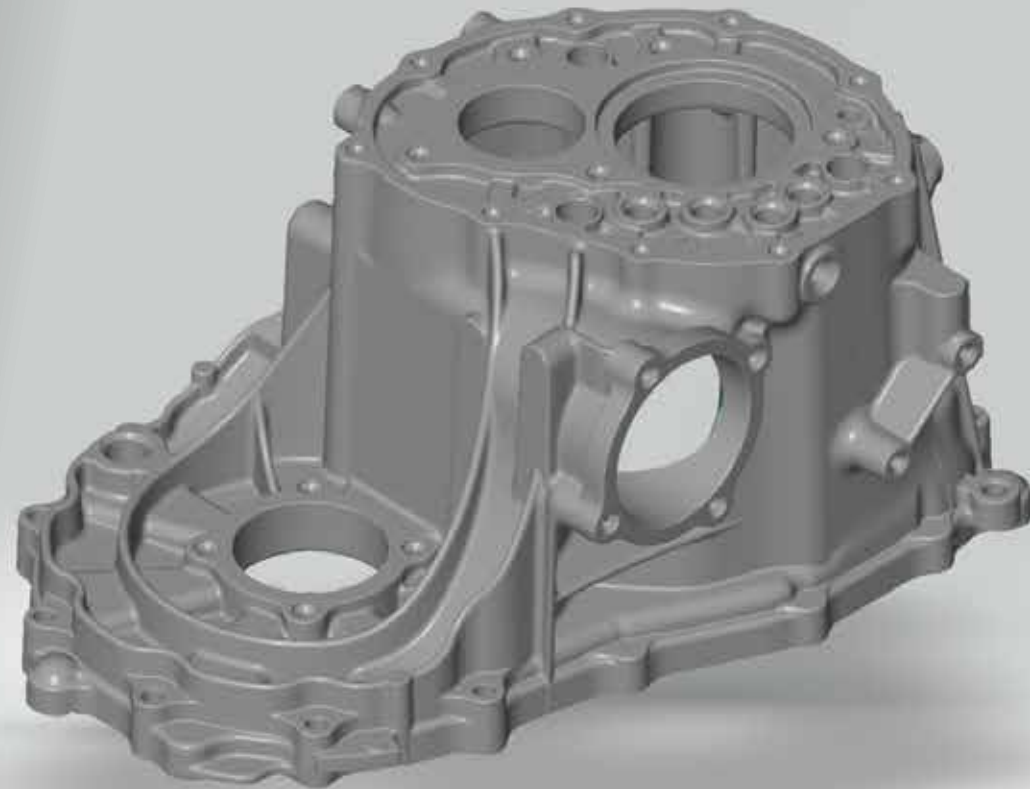

ZEISS
Certified Metrology Partner





3D-Scan & Photogrammetry



Quality assurance First article inspection



Computed Tomography

Reverse Engineering



Automated Inspection



Deformation- & displacement Inspection



AN EYE FOR THE ESSENTIALS

Our 3D metrology services in a nutshell

You need experts for the entire range, from 3D measurement technology to design? We are! Your exclusive GOM/ZEISS partner for Austria, Switzerland and Liechtenstein.

- As **your partner for industrial 3D measurement technology**, we stand for in-depth expertise, high-end equipment and comprehensive engineering services.

Optical or tactile? We can do both!

In optical metrology, the object to be measured is scanned without contact by means of light. With the tactile method, the surface of the object is detected by probing it.

Service Features optical:

- *3D Scan & Photogrammetry*
- *Quality Assurance & first article inspection*
- *Reverse Engineering*
- *Automated Inspection*
- *Computed Tomography*
- *Deformation & Displacement Inspection*

- *Roughness & Micro Measurement*
- *Visualization & Rendering*

Service Features tactile:

- *Precise tactile measurement with CMM*
- *Mobile and accurate inspection with measuring arms*
- *Laser tracker measurement*

• Reverse engineering (surface reconstruction):

Creation of a CAD model of real components based on a 3D or CT scan.

- Due to **Automated Inspection** processes, larger numbers of objects are digitized automatically and thus high throughput rates are achieved efficiently.
- X-ray technology (**Computed Tomography**) allows optically inaccessible areas, such as undercuts or internal structures, to be measured and further processed.

- **The specialist near you:** With measuring rooms in Baden (CH), Mils, St. Florian and Gleisdorf (A), we ensure short distances and a fast project flow.
- **Our cooperation – from small to large:** We are at your service with everything from the smallest engineering project to weighty tasks such as incoming goods inspection and production monitoring during series production.

The engineering services at a glance

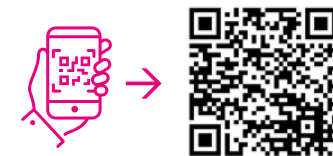

Typical optical 3D measuring system in use



FROM THE HEAD OF A PIN TO AN AIRPLANE

3D Scan & Photogrammetry

From small to large. Flexibly scalable. Where the highest accuracy is required, so are we. High-quality 3D scans & optical coordinate measuring technology.



Prototyping applications

- Depending on the customer application, we select the optimally suitable equipment from a **variety of optical & tactile measuring systems**.
- From a few millimeters up to components of several meters in size – we create an **exact "digital twin"** of your measured object.
- Depending on the size of the component, the achievable **measurement accuracies in the micrometer range**.



Measurement in the field

- **Maximum detail resolution** captures even the smallest element of the test specimen with high precision.
- **Mobile use possible:** We are happy to come to your site for data acquisition.
- Easily transportable components and tools are digitised **in one of our four measuring rooms** in Austria and Switzerland.

- The data output is an **STL file** and can be used for a wide range of subsequent processes: Quality assurance & metrology, reverse engineering & reconstruction, digital archiving, FE simulation on real data, use for additive manufacturing applications and many more.
- For regular part measurements in our measuring rooms, we offer **pick-up and delivery service** of the parts.

Learn more & watch videos

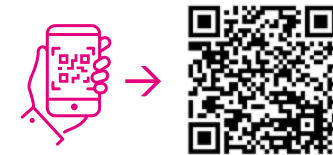



Case 5

ID	Normal	Actual	Dev.	Charact.
5	0.50	0.54	0.08	0.16
6	0.70(A-B-C)	0.12	0.58	0.84

Case 6

Y	Normal	Actual	Dev.
Avg	10.21	10.21	0.00
Stdev	10.21	10.21	0.00
Min	10.21	10.21	0.00
Max	10.21	10.21	0.00

Case 7

ID	Normal	Actual	Dev.	Charact.
7	0.50 (Part 1)	0.01	0.49	0.98
8	0.50(A-B-C)	0.01	0.49	0.98
9	0.50(Cow 1)	0.01	0.49	0.98

+0.11
-0.12
-0.21

Our measurement results: The basis for targeted decisions

A PICTURE SAYS MORE THAN 1.000 POINTS

Quality assurance & first article inspection

A full-surface measurement of the test specimen for a holistic statement of the geometric deviations? Yes, we can! Optical measurement technology for professional and meaningful results.



Pseudo color display

- **Meaningful pseudo color** for the evaluation of components with free-form surfaces: The technology is used, for example, in the evaluation of injection molded parts, castings, stamped and bent parts, 3D printed components and electrodes.
- Full-surface measurements contribute in particular to the simple and **intuitive assessment of shrinkage, warpage or rebound** of the component. Professional **evaluation of molds and tools** in tool-making and production.

- Added value results in the area of **allowance control before milling**, the evaluation of residual material in case of electrode or milling cutter breakage, in assembly analyses, and much more.
- **Initial sample inspection reports** with specific characteristics and dimensional evaluations are also possible. The **standardized component evaluation in VDA standard according to ISO 8015** is part of our standard repertoire.



3D deviation display as an intuitive optimization approach

We provide you with our **viewer and inspection software free of charge** for further processing and supplementing your evaluations.

Learn more & watch videos

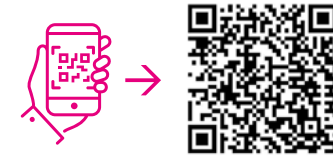

The digitization of complex parts also includes the inner geometries in the finest detail.



HE SEES THROUGH THEM ALL

Computed Tomography Inspection

Computed tomography as a measurement technology solution in the industrial environment? We offer it! And digitize your components including internal structures non-destructively.

- Industrial computed tomography (CT) is an elegant way of **non-destructively digitizing and evaluating** different components.
- **Analyses of air or gas inclusions** have become established for evaluating component strengths in industrial environments.
- Even the finest internal details are recorded for **geometric and dimensional evaluation**.
- The technology is used for **plastic, aluminum** and **steel parts** as well as multi-material components.
- Depending on the magnification, **measurement accuracies in the lower micrometer range** can be achieved.
- CT measurements are also suitable for **analyzing assembly situations**, e.g. for evaluating sealing surfaces, joints and the position of internal components.
- The latest devices deliver the **highest precision with maximum resolution** – for components from a few millimeters up to one meter in size.
- For further processing and supplementing your evaluations, we provide you with our **viewer and inspection software free of charge**.

Learn more & watch videos

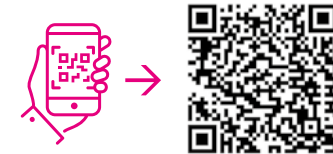

Detection of finest details on assemblies



Visualization of voids on volume data



3D scan of a hand-optimized prototype component for subsequent CAD data generation

THE WHAT FOR DETERMINES THE HOW

Reverse engineering needs experts

Modern technologies such as 3D scanners and CAD software require specialist process knowledge. We have it! And the strong solution for your idea – from the exact digital copy to the fully parametric data set.

- Not all reverse engineering is the same! The different possibilities of reverse engineering require **detailed coordination and consulting**. According to the motto: You explain your application to us and we consider a suitable solution for you based on the technical possibilities and our expertise.
- In the case of an **exact copy**, we create a precise three-dimensional model based on the real component using free-form surfaces. This variant is suitable, among other things, for 1 to 1 replicas and strongly free-formed components.
- In **parametric reconstruction**, the model is built up using ruled geometries. Thanks to special software solutions, the reconstruction is adapted very precisely to the high-precision 3D scan. The result is a three-dimensional, parametric CAD model that can be easily processed in all common CAD systems.
- **Hybrid modeling** combines exact copying with parametric reconstruction and offers the advantages of both variants.
- The **data output** is independent of the variant in **STL, IGES, STEP** or **native formats**.

Learn more & watch videos

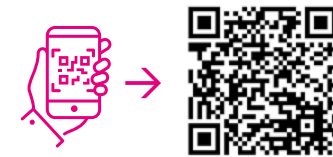

Use in harsh environment



Optimized design "brought back" to the digital world

Efficient measurement of larger batches in our ATOS ScanBoxes



PRECISION GOES INTO SERIES

Automated Inspection

Measuring and inspecting large quantities of components? We can! From the organization of the transport of the parts to the meaningful preparation of the measurement results.

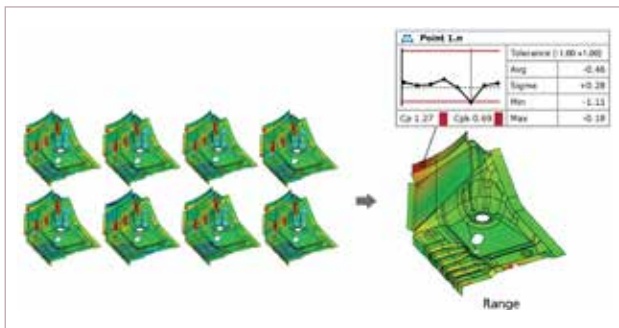

Derivation of process parameters and monitoring of the production process

- The digitization of larger quantities is carried out extremely efficiently in the **ATOS ScanBox** – from small parts with high detail requirements up to test specimens with a size of two meters.
- In addition to the measurement report for each individual part, you can also receive a **trend or SPC evaluation** for the entire batch on request.
- We provide you with our **viewer and inspection software free of charge** for further processing and supplementing your evaluations.



Recording of all relevant quality characteristics of the product

- As a reliable outsourcing partner, we are also available to cover **production peaks** and as a **vacation replacement**.
- We offer **pick-up and delivery service** of parts for regular component measurements in our measuring rooms.

Learn more & watch videos

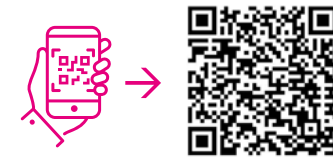

Typical test setup of a 3D testing application



STATIC, DYNAMIC OR HIGHSPEED Deformation- & Displacement Inspection

How do your components behave when loaded? Need professional help with testing? You get it!
From measurement setup to evaluation and interpretation.

- The testing of specimens or components under **force (mechanical or thermal)** can be realized intuitively and easily with optical measurement technology.
- Our range of services extends from support for classic material testing **to complex component tests**.
- The **displacements** and **strains of the specimen** are analyzed and evaluated.
- The evaluation of the component behavior is carried out **selectively and/or over the entire surface**.
- Depending on the application, a choice can be made between **static and dynamic measurements**.
- The **integration of peripheral signals** from the test environment enables synchronized and thus more easily interpretable test sequences.
- We provide you with our **viewer and inspection software free of charge** for further processing and supplementing your evaluations.

Learn more & watch videos

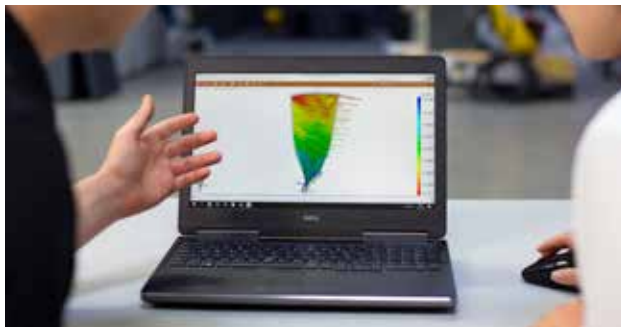
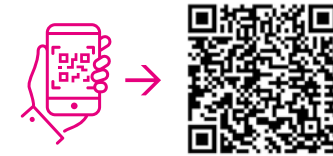

Analysis of strain and displacement



Spot or full area analysis

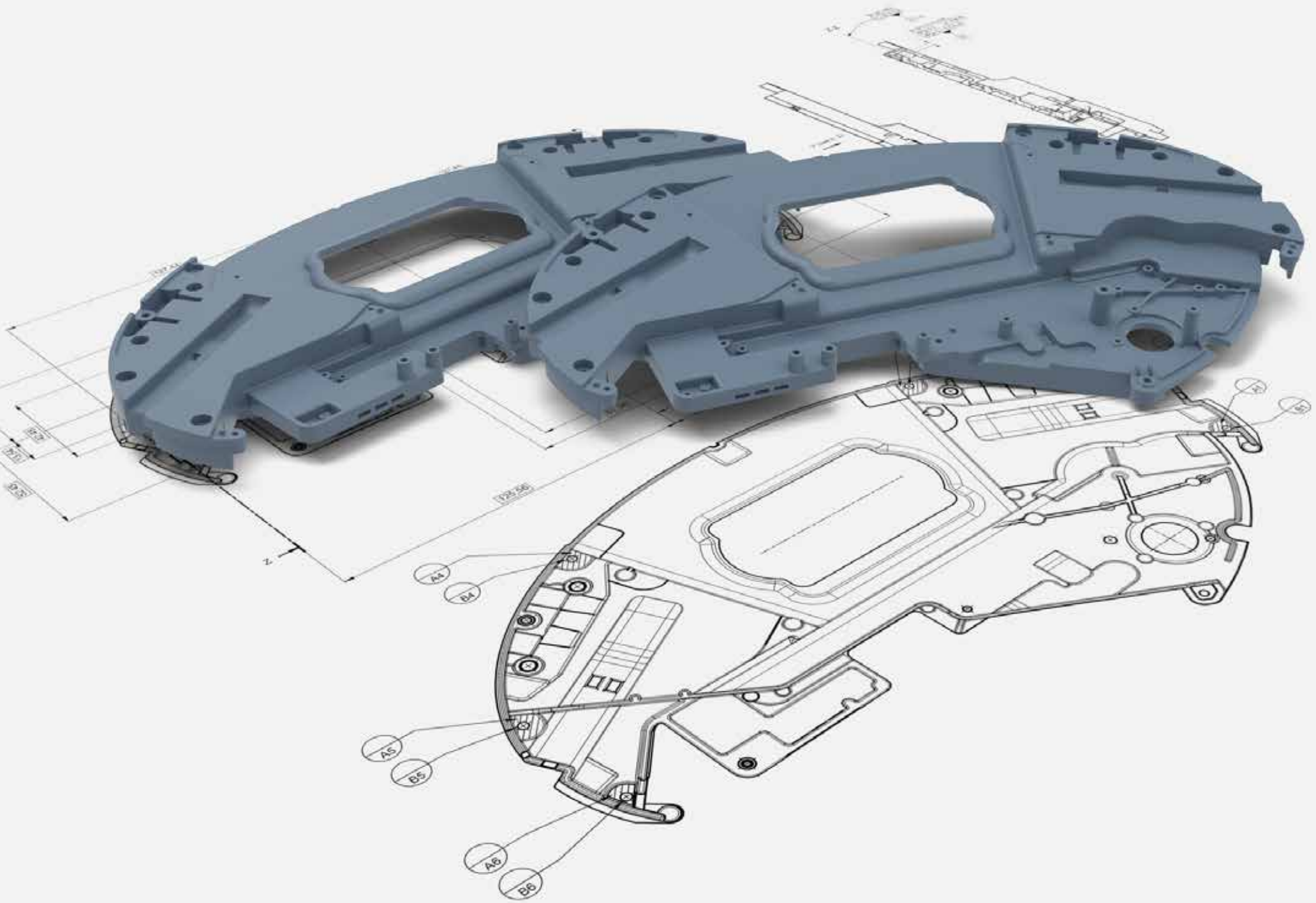

UP FOR EVERY KIND OF CHALLENGE

Plastics Know-WOW

3D measurement technology to accelerate all process phases in plastics technology? We've got it! Thanks to years of expert knowledge in 3D printing and injection molding simulation, we cover all phases of the production chain.

More than two decades of expertise in 3D printing for industrial manufacturing:

- On-demand manufacturing of design pieces and prototypes
- Targeted solutions for metal, plastic or sand printing
- Personalized advice on possible processes and materials
- Advanced training on 3D printing & design
- Optimization of your design for 3D printing
- Distribution of industrial 3D printers incl. software & materials



PT realization in all common materials

Know-how & practical experience in thermoplastic injection molding simulation:

- Customer-oriented evaluation and feasibility analysis
- Thermal development in the injection mold with stable process
- Material data of more than 11.000 plastics



Verification of the simulation

Over 23 years of 3D metrology experience for partners in the plastics industry:

- Use of the systems in product development, quality control as well as in material and component testing
- For faster component sampling, targeted workpiece correction and reduced production start-up times

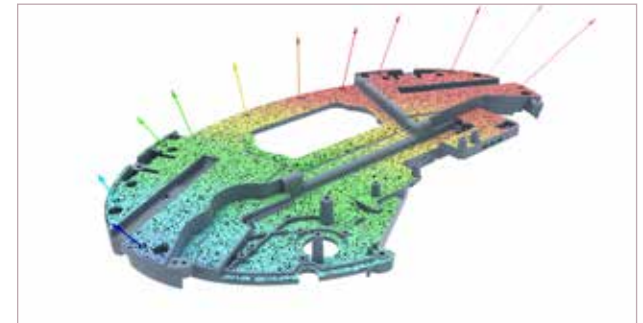





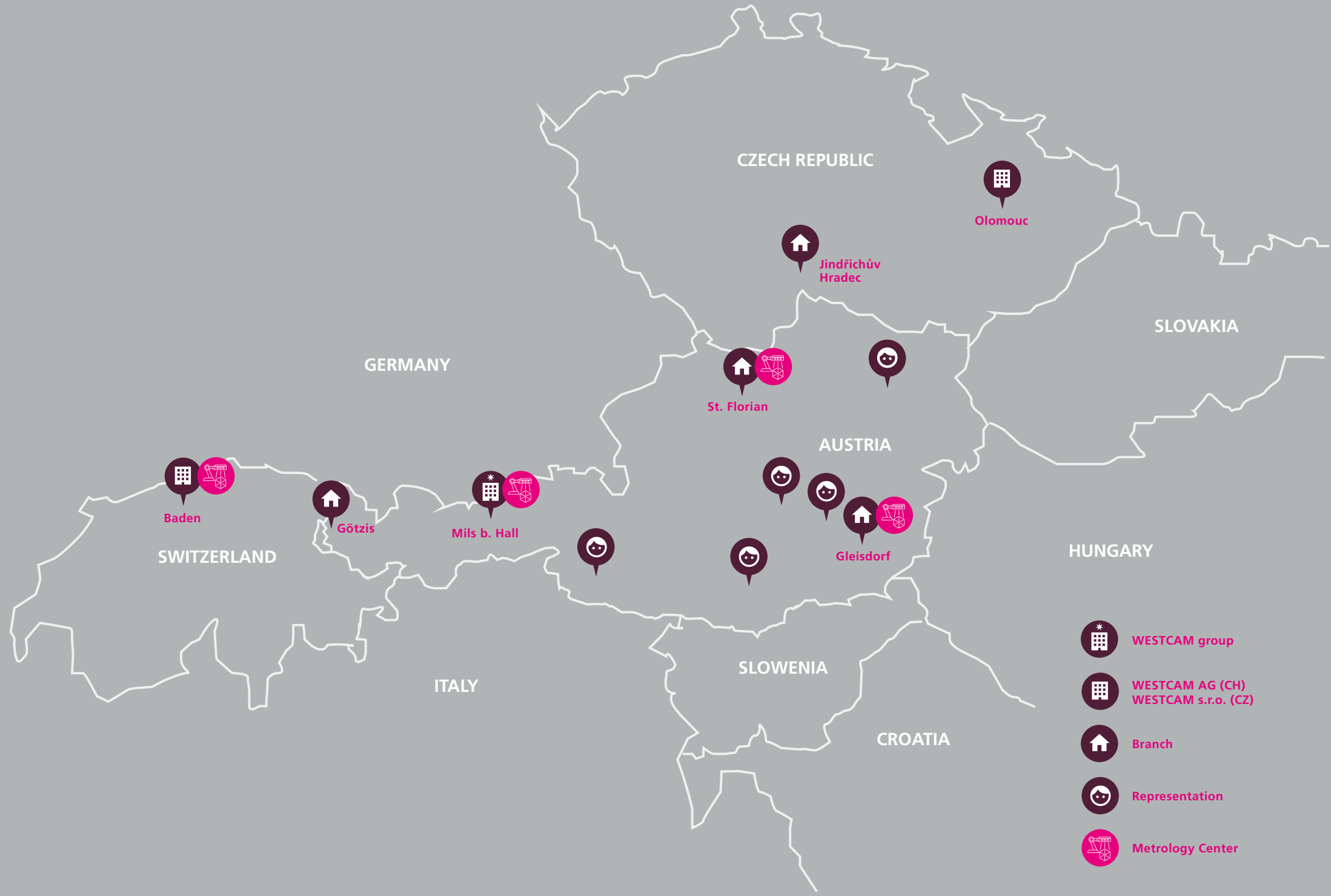

Warping optimization

Tailor-made – that concerns you & us: You would like a meaningful and above all as interesting as possible offer? Of course, we need some specific information from you. On the one hand information about the component or components themselves (size, weight, material, number of components to be measured) and on the other hand about the application as well as your expectations of our service.

Simply send us an e-mail to 3d-scan@westcam.at or 3d-scan@westcam.ch: CAD models, drawings, photos. The better we can get a picture of your task, the more customized your offer will be.





-  WESTCAM group
-  WESTCAM AG (CH)
WESTCAM s.r.o. (CZ)
-  Branch
-  Representation
-  Metrology Center



The Know-WOW Company
inspiring technologies

WESTCAM Datentechnik GmbH
Gewerbepark 38 · 6068 Mils · Austria
T +43 5223 55509-0 · 3d-scan@westcam.at

WESTCAM AG
Täferstrasse 1 · 5405 Baden · Switzerland
T +41 56 5614 600 · 3d-scan@westcam.ch

www.westcam.at
www.westcam.ch
www.westcam.li